

Zündgerät / Ignitor Type 295 – 400 V

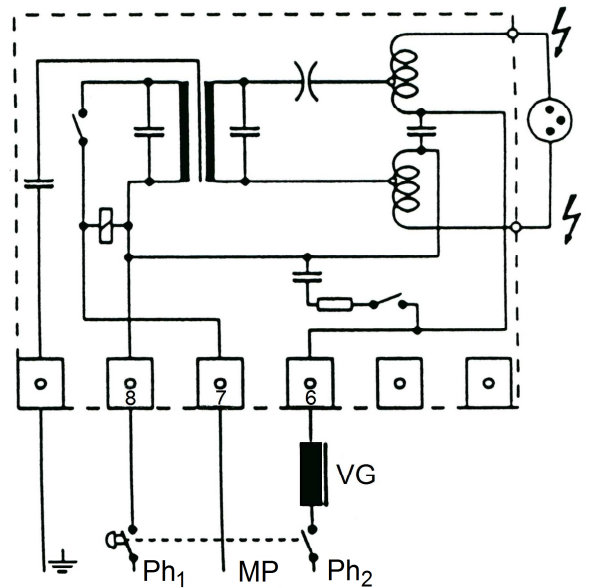
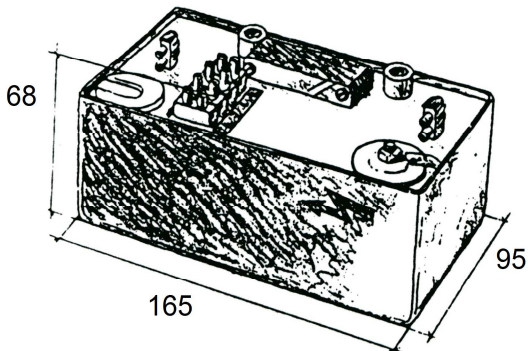

Für / For **HQI-TS 2000 W/D/S**

Technische Daten – Engineering Data

Zündspannung / Ignition voltage	36 KV (2*18 KV)
Lampenstrom max./ lamp current max.	23 A
Betriebsspannung / operating voltage	400 V AC 50/60Hz
Stromaufnahme / operating current	1,5 A / 230 V
Zuleitungskapazität/supply-capacity	5 – 30 pF
Umgebungstemperatur / ambient temperature	110°F 50°C
Nettogewicht / net weight	1,7 kg